

Varenummer: 203180M20100B1T
 Beskrivelse: E+G Justerfod
 GN 31-80-M20-100-B1-T
 Note: T Uden møtrik, spændeflade i bunden

Mål

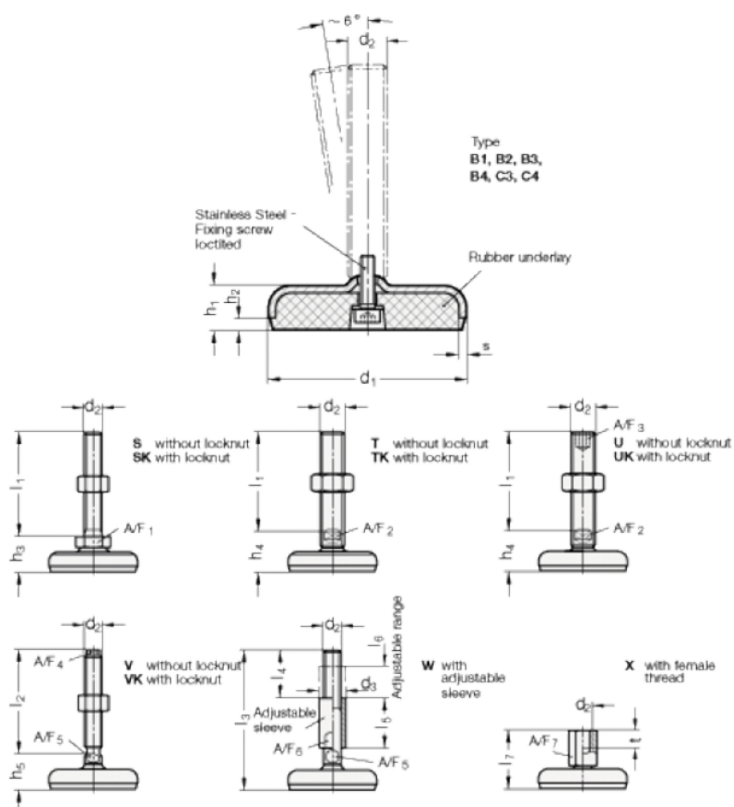

A/F2	= 15
d1	= 80
d2	= 20
h1	= 18
h2	= 5
h4 +4.0/0	= 33
l1	= 100
s	= 3